

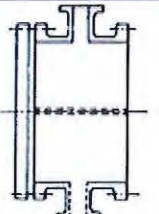

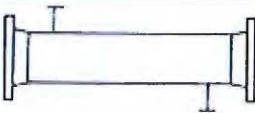
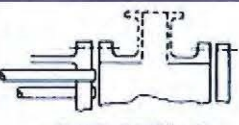
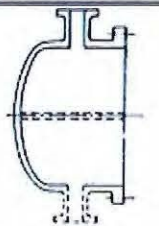
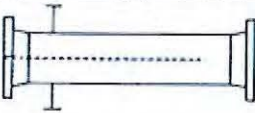
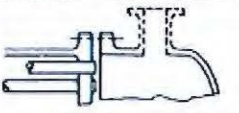
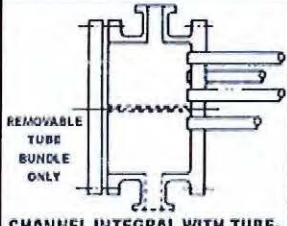
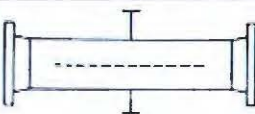
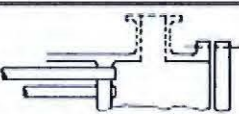
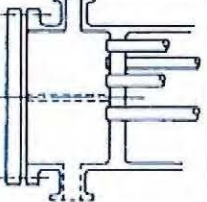
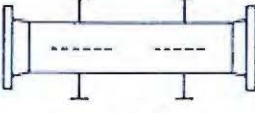
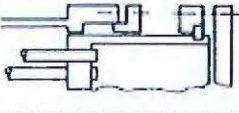
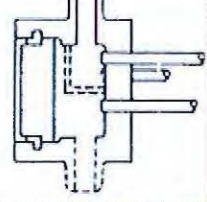
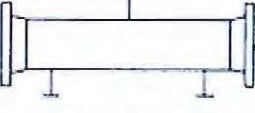
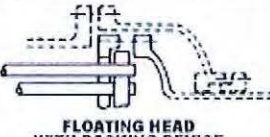
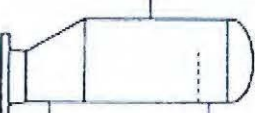

HEAT EXCHANGER NOMENCLATURE FIGURE N-1.2

FRONT END STATIONARY HEAD TYPES		SHELL TYPES		REAR END HEAD TYPES	
A	 CHANNEL AND REMOVABLE COVER	E	 ONE PASS SHELL	L	 FIXED TUBESHEET LIKE "A" STATIONARY HEAD
B	 BONNET (INTEGRAL COVER)	F	 TWO PASS SHELL WITH LONGITUDINAL BAFFLE	M	 FIXED TUBESHEET LIKE "B" STATIONARY HEAD
C	 REMOVABLE TUBE BUNDLE ONLY CHANNEL INTEGRAL WITH TUBE- SHEET AND REMOVABLE COVER	G	 SPLIT FLOW	N	 FIXED TUBESHEET LIKE "N" STATIONARY HEAD
N	 CHANNEL INTEGRAL WITH TUBE- SHEET AND REMOVABLE COVER	H	 DOUBLE SPLIT FLOW	P	 OUTSIDE PACKED FLOATING HEAD
D	 SPECIAL HIGH PRESSURE CLOSURE	J	 DIVIDED FLOW	S	 FLOATING HEAD WITH BACKING DEVICE
		K	 KETTLE TYPE REBOILER	T	 PULL THROUGH FLOATING HEAD
		X	 CROSS FLOW	U	 U-TUBE BUNDLE
				W	 EXTERNALLY SEALED FLOATING TUBESHEET

Standards of the Tubular Exchanger Manufacturers Association

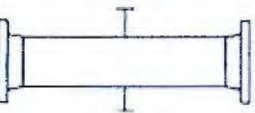
N-2 NOMENCLATURE OF HEAT EXCHANGER COMPONENTS

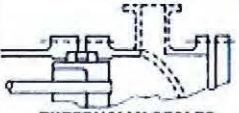
For the purpose of establishing standard terminology, Figure N-2 illustrates various types of heat exchangers. Typical parts and connections, for illustrative purposes only, are numbered for identification in Table N-2.

TABLE N-2

- | | |
|---------------------------------------------|------------------------------------------|
| 1. Stationary Head-Channel | 21. Floating Head Cover-External |
| 2. Stationary Head-Bonnet | 22. Floating Tubesheet Skirt |
| 3. Stationary Head Flange-Channel or Bonnet | 23. Packing Box |
| 4. Channel Cover | 24. Packing |
| 5. Stationary Head Nozzle | 25. Packing Gland |
| 6. Stationary Tubesheet | 26. Lantern Ring |
| 7. Tubes | 27. Tierods and Spacers |
| 8. Shell | 28. Transverse Baffles or Support Plates |
| 9. Shell Cover | 29. Impingement Plate |
| 10. Shell Flange-Stationary Head End | 30. Longitudinal Baffle |
| 11. Shell Flange-Rear Head End | 31. Pass Partition |
| 12. Shell Nozzle | 32. Vent Connection |
| 13. Shell Cover Flange | 33. Drain Connection |
| 14. Expansion Joint | 34. Instrument Connection |
| 15. Floating Tubesheet | 35. Support Saddle |
| 16. Floating Head Cover | 36. Lifting Lug |
| 17. Floating Head Cover Flange | 37. Support Bracket |
| 18. Floating Head Backing Device | 38. Weir |
| 19. Split Shear Ring | 39. Liquid Level Connection |
| 20. Slip-on Backing Flange | 40. Floating Head Support |

FIGURE N-2

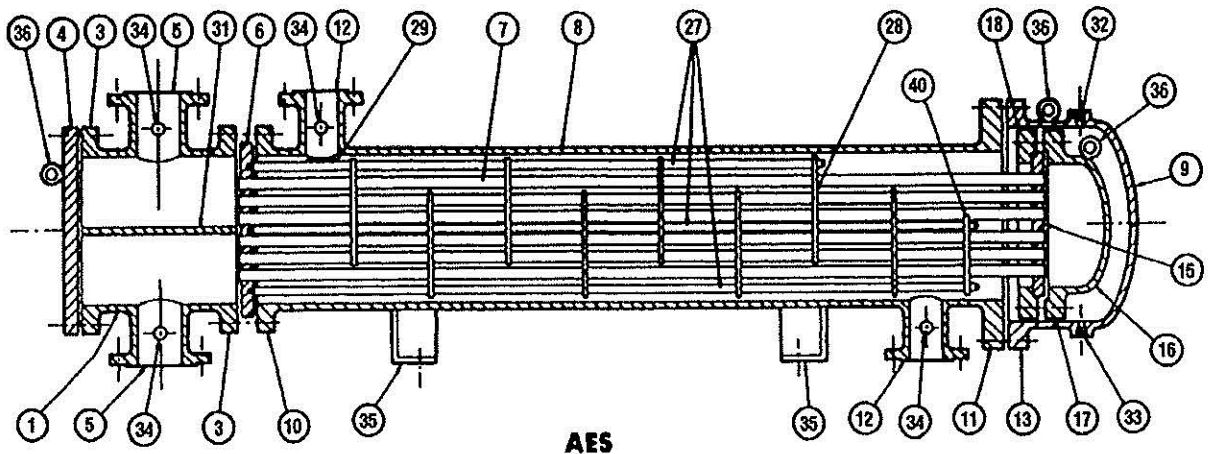

SECTION 1

HEAT EXCHANGER NOMENCLATURE

FIGURE N-2 (continued)

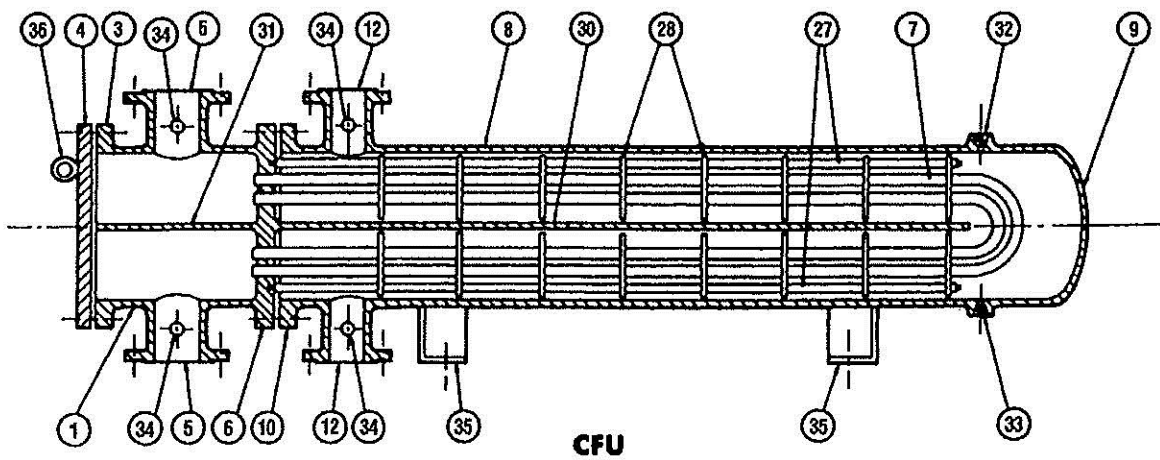
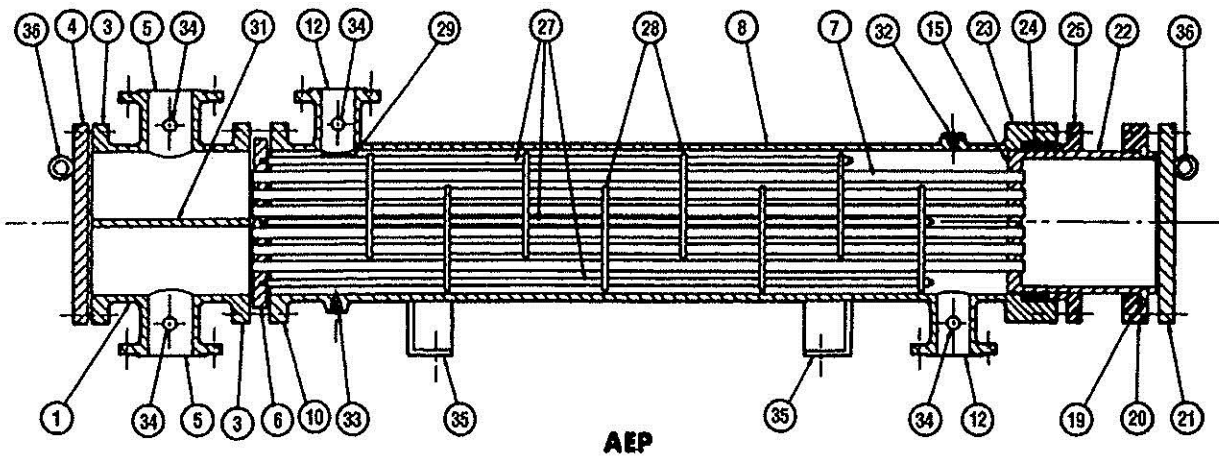
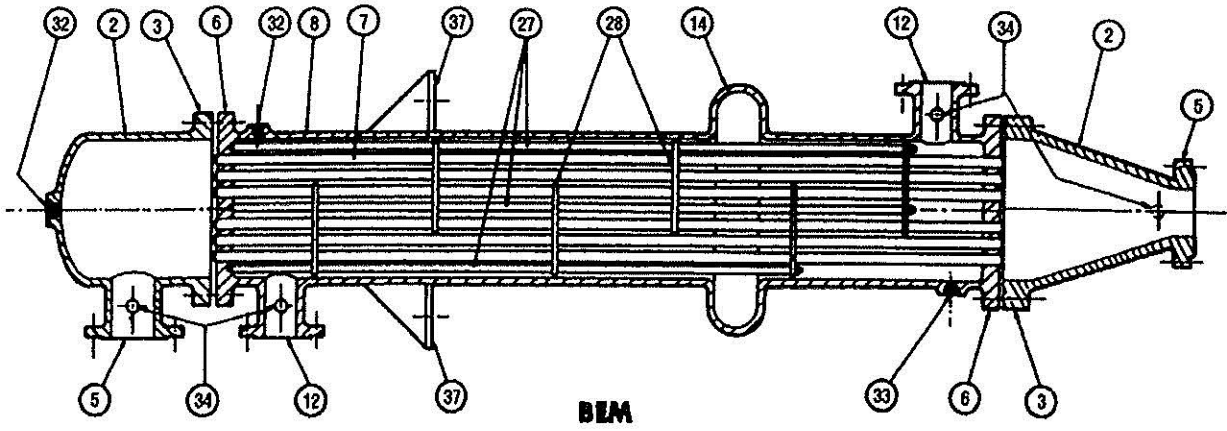

FIGURE N-2 (continued)

